

SHOWER HEAD

CROZET C10.CR04

CRANACH[®]

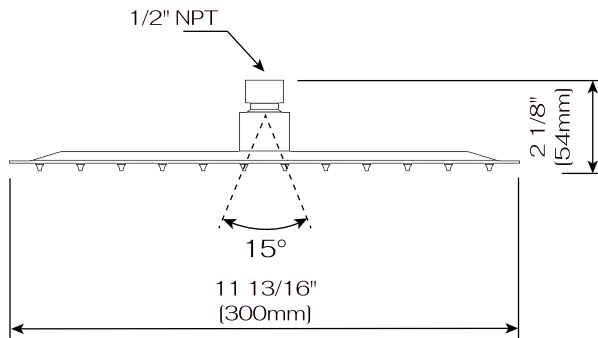
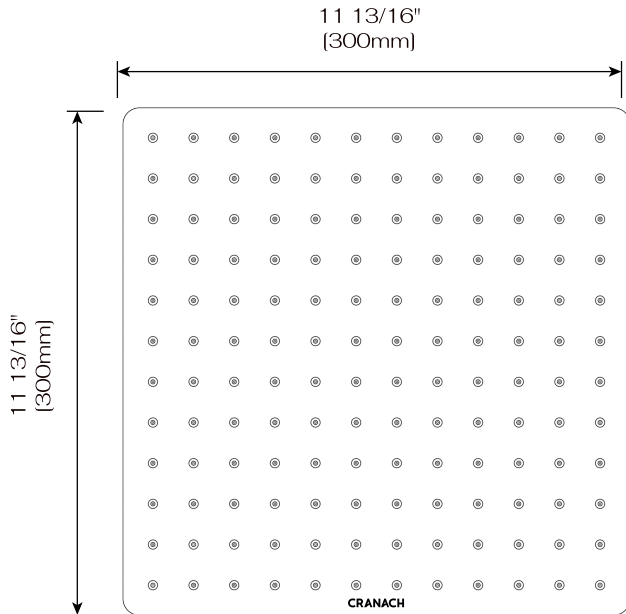

FEATURES

- Rain Spray
Wide and even water flow, relaxing and spa-like sensation.
- Brass Ball Joint
Durable adjustable joint, easy positioning of the showerhead.
- Easy Clean Spray Nozzles
Lime and calcium buildup prevention, hassle-free maintenance.
- Solid Stainless Construction
Premium stainless steel, durable and rust-resistant.

SPECIFICATION

- Rotation angle $\pm 15^\circ$
- 1/2" NPT female connection
- Finish Availability: Polished Chrome/Matte Black/Brushed Nickel/Brushed Gold
- Size: 11 13/16" (300mm)
- Shower arm and flange not included

FLOW

- 2.5 GPM @ 80 PSI MAX

WARRANTY

- Parts and Finish: Limited lifetime warranty for residential, or 10 years for commercial purchasers and multi-family (apartments and condominiums) residential, in each case from the date of purchase.

STANDARDS

- ASME A112.18.1/CSA B125.1

Cranach deserves the right to make changes in specifications and materials and to change or discontinue models both without notice or obligation. Dimensions are only for reference only.